

1-1-2015

## Epilepsy diagnosis using artificial neural network learned by PSO

NESİBE YALÇIN

GÜLAY TEZEL

CİHAN KARAKUZU

Follow this and additional works at: <https://journals.tubitak.gov.tr/elektrik>



Part of the [Computer Engineering Commons](#), [Computer Sciences Commons](#), and the [Electrical and Computer Engineering Commons](#)

### Recommended Citation

YALÇIN, N, TEZEL, G, & KARAKUZU, C (2015). Epilepsy diagnosis using artificial neural network learned by PSO. *Turkish Journal of Electrical Engineering and Computer Sciences* 23 (2): 421-432. <https://doi.org/10.3906/elk-1212-151>

This Article is brought to you for free and open access by TÜBİTAK Academic Journals. It has been accepted for inclusion in Turkish Journal of Electrical Engineering and Computer Sciences by an authorized editor of TÜBİTAK Academic Journals. For more information, please contact [academic.publications@tubitak.gov.tr](mailto:academic.publications@tubitak.gov.tr)

## Epilepsy diagnosis using artificial neural network learned by PSO<sup>†</sup>

Nesibe YALÇIN<sup>1,2,\*</sup>, Gülay TEZEL<sup>3</sup>, Cihan KARAKUZU<sup>1</sup>

<sup>1</sup>Department of Computer Engineering, Bilecik Şeyh Edebali University, Bilecik, Turkey

<sup>2</sup>Institute of Natural Sciences, Sakarya University, Sakarya, Turkey

<sup>3</sup>Department of Computer Engineering, Selçuk University, Konya, Turkey

Received: 26.12.2012 • Accepted: 21.03.2013 • Published Online: 23.02.2015 • Printed: 20.03.2015

**Abstract:** Electroencephalogram (EEG) is used routinely for diagnosis of diseases occurring in the brain. It is a very useful clinical tool in the classification of epileptic seizures and the diagnosis of epilepsy. In this study, epilepsy diagnosis has been investigated using EEG records. For this purpose, an artificial neural network (ANN), widely used and known as an active classification technique, is applied. The particle swarm optimization (PSO) method, which does not need gradient calculation, derivative information, or any solution of differential equations, is preferred as the training algorithm for the ANN. A PSO-based neural network (PSO-NN) model is diversified according to PSO versions, and 7 PSO-based neural network models are described. Among these models, PSO-NN3 and PSO-NN4 are determined to be appropriate models for epilepsy diagnosis due to having better classification accuracy. The training methods-based PSO versions are compared with the backpropagation algorithm, which is a traditional method. In addition, different numbers of neurons, iterations/generations, and swarm sizes have been considered and tried. Results obtained from the models are evaluated, interpreted, and compared with the results of earlier works done with the same dataset in the literature.

**Key words:** Artificial neural networks, backpropagation algorithm, electroencephalogram, epilepsy diagnosis, particle swarm optimization

### 1. Introduction

Epilepsy is a major disease occurring in the brain. Wave forms contained in electroencephalograms (EEGs) recorded during the occurrence of epileptic seizures are similar to wave forms of some other brain disorders. Thus, epilepsy cannot be recognized easily [1]. EEG signals as shown in Figure 1 are not periodic; their phase, amplitude, and frequency change constantly. The changing forms of EEG signals are complex and difficult to interpret and define [2,3]. Therefore, a doctor making a diagnosis should be a good observer and have considerable experience.

In recent years, recognition and diagnostic studies of EEG signals using artificial intelligence methods have been studied quite extensively. Artificial neural networks (ANNs), one of the artificial intelligence methods, are widely used in the classification of EEG signals because of their fast response in analyzing many samples of EEG signals in a second [4]. In addition to these methods, heuristic optimization algorithms are used to increase the success and/or the speed of these methods. Particle swarm optimization (PSO) as a heuristic optimization method has been successfully applied to train ANNs. It has been proposed to update network weights because of

\*Correspondence: nesibe.yalcin@bilecik.edu.tr

<sup>†</sup>This is the updated and extended version of a paper by the same title presented at ICECCO '12, Ankara, Turkey.

its easy implementation and realization, the small number of parameters to be set, and capability for treatment with real numbers, not derivative information [5]. The related works in the literature are presented as follows in descending order of the year published.

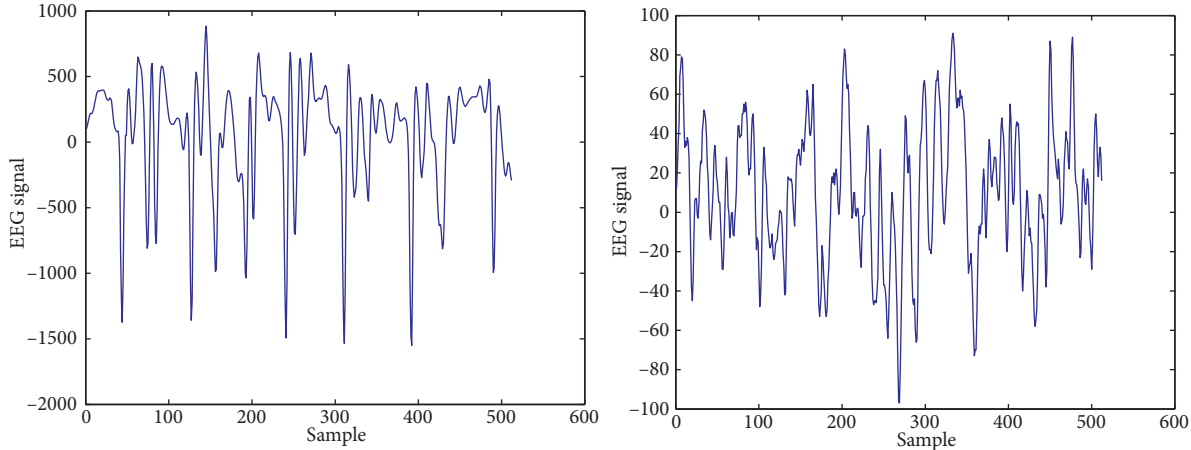

**Figure 1.** Examples of EEG signals a) for an epileptic person and b) for a healthy person.

Akın et al. [6] aimed to find a solution for diagnosing epilepsy by using wavelet transform and an ANN model. For this purpose, EEG signals were separated into spectral components ( $\alpha$ ,  $\beta$ ,  $\theta$ , and  $\delta$ ) by using wavelet transform [6]. These components were then given to inputs of the neural network and the neural network was trained. The diagnostic accuracy rates obtained were 97% for epileptic, 98% for healthy, and 93% for pathologic records.

In order to diagnose epilepsy, Barışçı and Müldür [1] applied fast Fourier transform (FFT) spectral analysis to each EEG signal taken from 40 patients. These preprocessed signals were classified using a neuro-fuzzy system and they achieved a 90% correct classification rate for diagnosis.

Subaşı et al. [7] developed a wavelet neural network as a classifier to determine the presence of epilepsy from EEG records. Autoregressive spectrums were given as inputs to the neural network with 2 discrete outputs (epileptic seizure/non epileptic seizure). The developed network was compared with a backpropagation neural network, and an increase of classification accuracy was observed.

Kannathal et al. [8] computed entropy measures to give as inputs to the adaptive neuro-fuzzy inference system (ANFIS) classifier and then tested the classification ability of the entropy measures. The classification accuracy obtained was about 90%.

Güler and Übeyli [9] proposed the multiclass support vector machine (SVM) for EEG signal classification through the use of composite features. They also investigated a probabilistic neural network (PNN) and multilayer perceptron neural network (MLPNN) and tested their performances. The classification accuracy rates of multiclass PNN and SVM were found to be better than that of the MLPNN.

Polat and Güneş [10] developed a hybrid system based on a decision tree and FFT to detect epileptic seizures in EEG signals. They obtained 98.72% classification accuracy using 10-fold cross-validation.

Subaşı proposed an approach based on mixture of experts (ME) for epileptic seizure detection in [11] and used statistical features of discrete wavelet transform of subband frequencies as inputs of MLPNN and ME classifiers. He obtained 94% specificity and 95% sensitivity for the ME classifier and 92.6% specificity and 93.6% sensitivity for the MLPNN-based classifier.

Tzallas et al. proposed a time frequency (TF)-based method for the analysis of EEG signals in [12]. They analyzed segments of EEG signals using TF, extracted features for each segment, and then used these features as inputs of ANN. They obtained 99% accuracy in classification of the EEG signals.

Hema et al. [13] presented a classification algorithm for epilepsy diagnosis using a PSO-based neural network (PSONN) model. Five different mental tasks (baseline measurement, complex problem solving, geometric figure rotation, mental letter composing, and visual counting) of 2 subjects were studied. A combination of 2 tasks was studied for task classification for each subject. Principal component analysis was used for feature extraction and then the features were used to train and test the neural network. Classification accuracy rates varied from 77.5% to 100% for the 10 different task combinations for each of the subjects.

Sezer [4] aimed to perform classification of epilepsy diagnoses via various ANNs in her MSc thesis. EEG signals were separated into the frequency subbands using wavelet analysis; statistical features were obtained from these subbands. The number of obtained feature vectors was then reduced and they were given to multilayer perception (MLP), Elman, and linear vector quantization neural networks and other ANNs as inputs. The networks without MLP learned quickly; 2-layer MLP structures were more successful than single-layer ones.

Guo et al. [14] proposed an ANN-based system for analysis of EEG signals using relative wavelet energy. Considerable classification accuracy (95.2%) was achieved.

Tezel and Özbay [15] proposed new neural network models with adaptive activation function to detect epileptic seizures. The proposed models were trained and tested using 5-fold cross-validation to find the best model. They achieved 100% average sensitivity, 100% average specificity, and approximately 100% average classification rate for all models.

In [16], Wang et al. extracted features using an entropy method-based wavelet packet and then used the cross-validation method and k-nearest neighbor (KNN) classifier in the training phase. The best classification accuracy was about 100% using cross-validation.

This work aimed to diagnose epilepsy from EEG records quickly and accurately using PSO-based ANN models and to determine the best classifier among the PSO-based ANN models. For these purposes, EEG signals received from healthy and epileptic volunteers were normalized and then used to train and test different versions of PSONN models and improve the performance of these models.

Following this introductory section, the rest of the paper is organized as follows: in the next section, materials and methods used in this study and the procedures used to train the ANN with the backpropagation and PSO algorithms are explained. In Section 3, experimental studies are presented and the performances of the PSONNs and backpropagation neural network (BPNN) are compared. In the final section, the results are summarized and conclusions are drawn.

## 2. Materials and methods

### 2.1. EEG dataset

EEGs are used for diagnosing diseases occurring in the brain, especially epilepsy. In this study, publicly accessible EEG data, defined in [17], were used.

The data consist of 5 sets. Set A and Set B include data received from healthy (nonepileptic) volunteers while their eyes were open and closed, respectively. Activities measured in intervals without seizures are in Set C and Set D, and only epileptic seizure activity is in Set E [15,17]. All EEG signals were recorded with the same 128-channel amplifier system using an average common reference. The data were digitized at 173.61 samples per second using 12-bit resolution. Band-pass filter settings were 0.53 and 40 Hz (12 dB/octave) [15].

In this work, we have used Set A and Set E. The dataset was prepared with 1600 segments (800 segments for each class, epileptic and healthy) and 512 samples for each segment. The dataset was preprocessed using statistical features, which are the minimum, maximum, mean, and standard deviation of each sample; thus, the number of samples in each segment was reduced to 4. The new dataset was normalized in the range of [0, 1] using Eq. (1):

$$X_s^{norm} = \frac{X_s - X_{min}}{X_{max} - X_{min}} \quad , \quad (1)$$

where  $X_s$  is the value of the  $s$ th ( $s = 1, 2, \dots, 1600$ ) segment to be normalized and  $X_{max}$  and  $X_{min}$  are the maximum and minimum values of the data.

### 2.2. Neural network learned by backpropagation

Backpropagation [18] is generally used to train multilayer ANNs. A multilayer backpropagation network includes an input layer, at least one hidden layer, and an output layer. The backpropagation algorithm is a supervised learning method and aims to optimize weights and biases between the input layer and the output layer depending on the output error of the network. The input vector is given to the input layer and reaches the final output layer after passing through hidden layers. Each neuron in the network transmits the result to all neurons of the next layer after receiving the arithmetical addition of the weighted signal from the previous layer's neurons, depending on the activation function.

The ANN's training by backpropagation operates consistently in both forward computing and backward computing, as given in Figure 2, where  $X1$  and  $X2$  are inputs and  $C1$ ,  $C2$ , and  $C3$  are output vectors of the layers.  $W1$  and  $W2$  are weight matrices;  $W3$  is a weight vector;  $\theta1$ ,  $\theta2$ , and  $\theta3$  are bias vectors; and  $E1$ ,  $E2$ , and  $E3$  bias inputs are chosen as 1. NET1, NET2, and NET3 are net input vectors for the related layer. Sigmoid activation function ( $\varphi$ ) is preferred for all neurons.  $\varphi'$  is the derivative of the activation function.  $\delta1$ ,  $\delta2$ , and  $\delta3$  are local gradient vectors.

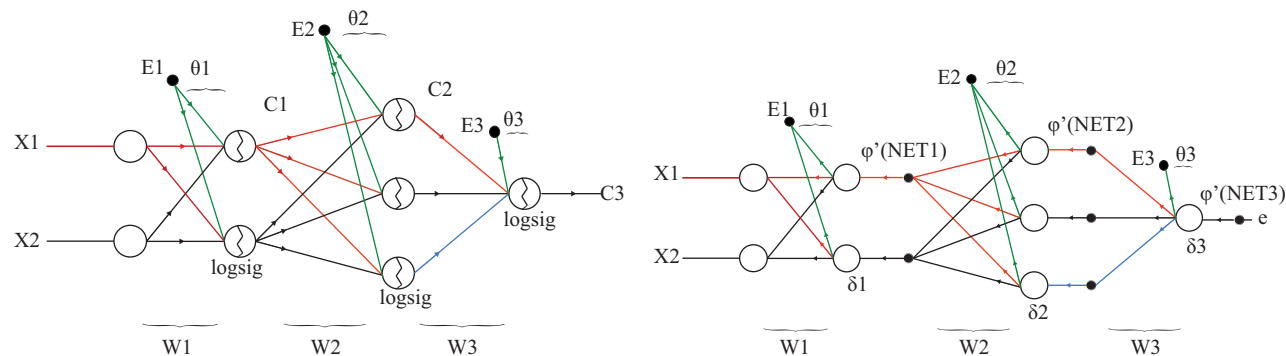

**Figure 2.** a) Forward computing schematic structure; b) backward computing schematic structure (transpose network).

### 2.3. Neural network learned by PSO

PSO, one of the population-based heuristic optimization methods, was first developed by Kennedy and Eberhart in 1995 [19], inspired by social behavior in flocks of birds or schools of fish while finding food.

The PSO algorithm is initialized with a group of random particles (candidate solutions for the problem) and then searches for an optimal solution by updating its individuals. In each generation, each particle is updated based on 2 special particles:  $pbest$  is the personal best solution of each particle found so far, and  $gbest$

is the global best solution found so far by any particle in the swarm (population) [20,21]. Figure 3 shows the updating procedure of a particle by vectorial representation.

The algorithm's pseudocode is the following:

**for** each particle **do**

    initialize the particle with random values

**end for**

**Do**

**for** each particle **do**

        Calculate fitness value of the particle

**if** fitness value of the current particle < fitness value of the pbest particle **then**

            update the pbest particle

**end if**

**end for**

    gbest = the particle whose fitness value is equal to min(fitness values of all particles)

**for** each particle **do**

        update velocity and position of the current particle

**end for**

**while** stop criterion (maximum generation number or target fitness value of the gbest particle) is provided

The  $v_{ij}^k$  and  $x_{ij}^k$  variables in Figure 3 are respectively the  $j$ th velocity component and the  $j$ th ( $j = 1, 2, \dots, D$ ) position component of the  $i$ th ( $i = 1, 2, 3, \dots, N$ ) particle at generation  $k$ .  $N$  is the number of particles in the swarm.  $D$  is the dimension size of the search space.

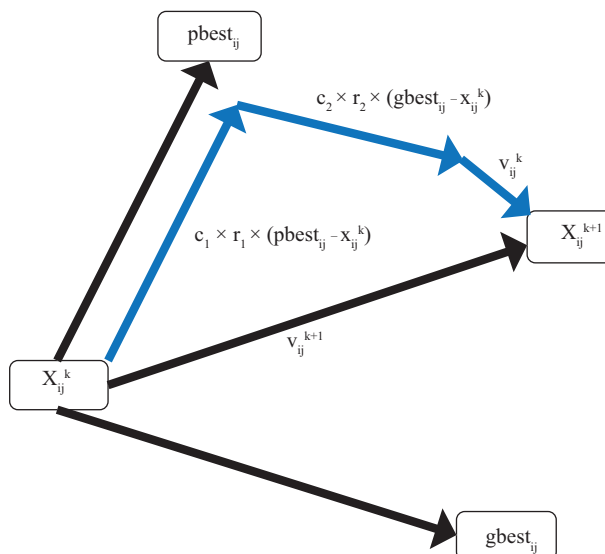

**Figure 3.** The velocity and position updating of a particle at  $k$ th generation [22,23].

For the basic PSO [19], the velocity updating and the position updating are calculated by Eqs. (2) and (3), respectively. In these equations,  $r_1$  and  $r_2$  are 2 uniformly distributed random numbers in the interval of

(0, 1).  $c_1$  and  $c_2$  are positive acceleration constants, usually  $c_1 = c_2 = 2$ .

$$v_{ij}^{k+1} = v_{ij}^k + c_1 \times r_1 \times (pbest_{ij} - x_{ij}^k) + c_2 \times r_2 \times (gbest_i - x_{ij}^k) \quad (2)$$

$$x_{ij}^{k+1} = x_{ij}^k + v_{ij}^{k+1} \quad (3)$$

In an improved PSO version [24], an inertia weight ( $w$ ) parameter shown in Eq. (4) is added into the equation of velocity updating.

$$v_{ij}^{k+1} = w^k \times v_{ij}^k + c_1 \times r_1 \times (pbest_{ij} - x_{ij}^k) + c_2 \times r_2 \times (gbest_i - x_{ij}^k) \quad (4)$$

$w$  is used to balance the global and local search [24] and can be updated using Eq. (5) or (6) by generations. In Eq. (5),  $w_{max}$  and  $w_{min}$  are maximum and minimum values of inertia weight;  $n$  is maximum generation number. The  $\alpha$  variable in Eq. (6) is the decrease factor and is used to linearly decrease inertia weight.

$$w^k = w_{max} - k \times \frac{(w_{max} - w_{min})}{n} \quad (5)$$

$$w^{k+1} = \alpha \times w^k \quad (6)$$

The velocity updating can be also determined using Eq. (7) [25] and Eq. (11) [5].  $\chi$  is a constriction factor that provides convergence to the target under the specified limits and is calculated by one of the (8)–(10) or (9)–(10) equation pairs.

$$v_{ij}^{k+1} = \chi \times [v_{ij}^k + c_1 \times r_1 \times (pbest_{ij} - x_{ij}^k) + c_2 \times r_2 \times (gbest_i - x_{ij}^k)] \quad (7)$$

$$\beta = c_1 + c_2 \quad (8)$$

$$\beta = c_1 \times r_1 + c_2 \times r_2 \quad (9)$$

$$\chi = \frac{2}{\left| 2 - \beta - \sqrt{\beta \times (\beta - 4)} \right|} \quad (10)$$

An  $R$  vector was used in an alternative velocity updating approach given by Çavuşlu et al. [5]. The  $R$  vector used in Eq. (11) consists of normally distributed random numbers and provides very small changes in velocity updating of the particles.  $\alpha$  is a small extra learning constant, and  $10^{-5}$  was chosen here.

$$v_{ij}^{k+1} = \chi \times [v_{ij}^k + c_1 \times r_1 \times (pbest_{ij} - x_{ij}^k) + c_2 \times r_2 \times (gbest_i - x_{ij}^k)] + \alpha \times R_{ij} \quad (11)$$

In Eq. (12),  $V_{min}$  and  $V_{max}$  limitations are the minimum and maximum limit values of a particle during one generation. They are used to supply detailed searching and to prevent the particles from leaving the space.

$$v_{ij}^{k+1} = \begin{cases} v_{ij}^{k+1}, & V_{min} < v_{ij}^{k+1} < V_{max} \\ V_{min}, & v_{ij}^{k+1} \leq V_{min} \\ V_{max}, & V_{max} \leq v_{ij}^{k+1} \end{cases} \quad (12)$$

In this study, PSO is used to train an ANN to obtain an optimum network model and to improve the performance of the ANN. During the training phase, the mean squared error (MSE) is used to calculate the fitness value of

a particle ( $P_i$ ) by Eq. (13), where  $e$  is the error between desired and obtained outputs after presenting the  $i$ th datum to the network, and  $S$  is the number of data in the training dataset. The structure of the  $P_i$  particle is given by Eq. (14).

$$MSE = \frac{1}{2S} \sum_{i=0}^S e_i^2 \tag{13}$$

$$P_i = [W1_{11}^i \ W1_{12}^i \ \dots \ \theta1_{11}^i \ \dots \ W2_{11}^i \ W2_{12}^i \ \dots \ \theta2_{11}^i \ \dots \ W3_1^i \ \dots \ \theta3_{11}^i \ \dots] \tag{14}$$

The flowchart given in Figure 4 [23] shows the training and testing processes of the PSO. The ANN's training process starts with random initialization of weights and biases, which indicates the numerical values of the connections between layers. These weights and biases are individuals to each particle, as given in Eq. (14). The number of connections between layers refers to the particle size or search space dimension. The stop criterion in Figure 4 is chosen as the maximum generation number or target fitness value of the *gbest* particle.

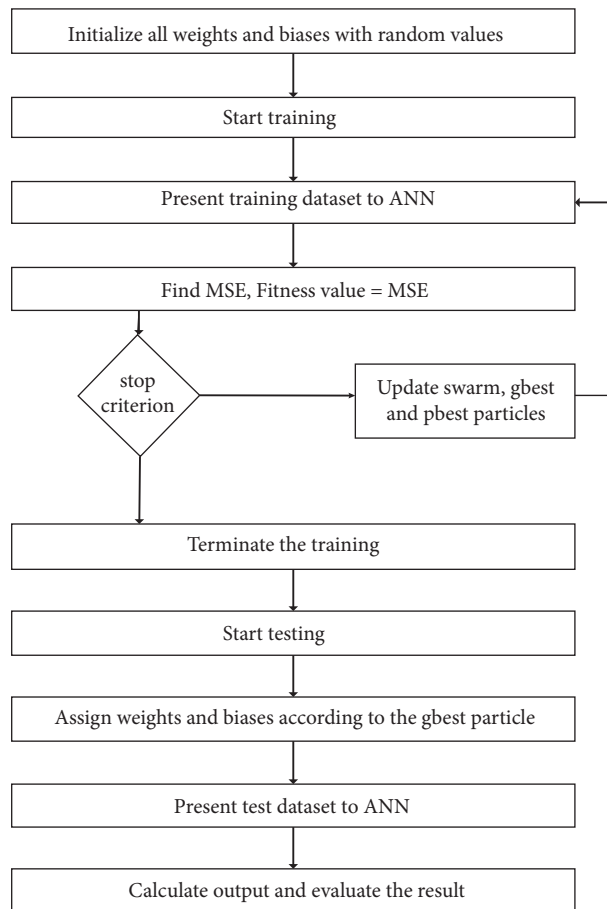

**Figure 4.** Flowchart for the training and testing of the PSO.

PSO models created with the use of PSO versions for the training of the ANN and equations used for these models are given in Table 1.

**Table 1.** Equations used in PSONNs.

PSO model	Velocity update Eq. No.	Inertia weight Eq. No.	Constriction factor Eq. No.
PSO1	Eq. (2)	-	-
PSO2	Eq. (4)	Eq. (5)	-
PSO3	Eq. (4)	Eq. (6)	-
PSO4	Eq. (7)	-	Eq. (8) and Eq. (10)
PSO5	Eq. (7)	-	Eq. (9) and Eq. (10)
PSO6	Eq. (11)	-	Eq. (8) and Eq. (10)
PSO7	Eq. (11)	-	Eq. (9) and Eq. (10)

### 3. Experimental studies

In this work, an EEG dataset with data from both epileptic and healthy people was used. The dataset was preprocessed using statistical values (minimum, maximum, mean, and standard deviation) to give as inputs for diagnosing systems, and so the number of samples was reduced. The dataset was then normalized in the range of [0, 1] to increase the performance of the neural network. The dataset was divided into 2 subsets for training and testing of the networks. There are 1200 segments (600 epileptic and 600 healthy) and 400 segments (200 epileptic and 200 healthy) of EEG data in the training and test datasets, respectively.

The training dataset was used to train the PSONNs and BPNN. Each network consists of an input layer, a hidden layer, and an output layer, as shown in Figure 5. X1, X2, X3, and X4 are inputs obtained from statistical values as depicted above; Y is the output. The desired output value is 0 for healthy and 1 for epileptic. W1 and W2 are connection weight matrices;  $\theta_1$  and  $\theta_2$  are bias vectors. Threshold inputs are used in the layers; their values are chosen as 1. Sigmoid activation function was preferred.

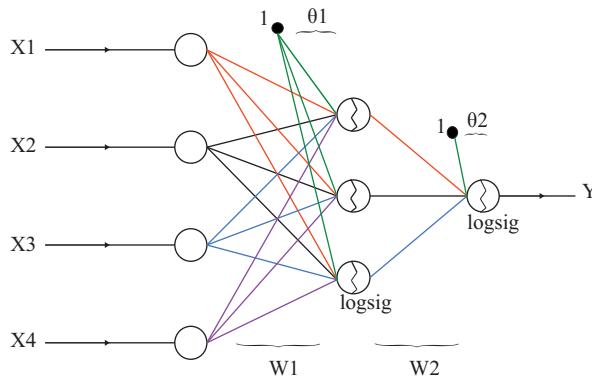

**Figure 5.** Schematic structure of the neural network.

To determine the best classifier network model and architecture, the number of particles, maximum generation, and neurons in the hidden layer were investigated by trial and error for each model. As a result of the experimental evaluations, the most suitable values of these parameters were determined to be 30, 200, and 3, respectively [23].

The optimal threshold value has to be determined to minimize false negatives (FNs) while maintaining false positives (FPs) within a reasonably low limit [26]. Thus, the appropriate FN and FP values were obtained when the classification threshold value was chosen as 0.4 in both training and testing. If the output value is lower than this value, the output signifies that the patient is healthy; if higher, the patient is epileptic.

Initialization values of  $\alpha$  and  $w$  in Eq. (6) were chosen as 0.975 and 0.9, respectively [27].  $w_{max}$  and  $w_{min}$  were 0.9 and 0.4 [28].  $c_1$  and  $c_2$  constants were 2.1 and equal to each other. Limitations  $V_{min}$  and  $V_{max}$  were selected as -0.1 and 0.1, respectively. These values provided fast convergence to the target.

Sensitivity, specificity, and accuracy are widely preferred statistics in determining the performance of a classifier. Sensitivity is the estimation rate of data belonging to epileptic patients, specificity is the estimation rate of data belonging to healthy people, and accuracy is the true classification rate [29]. Eqs. (15), (16), and (17) are used to calculate these statistical numbers.

$$Sensitivity = \frac{TP}{TP + FN} \tag{15}$$

$$Specificity = \frac{TN}{TN + FP} \tag{16}$$

$$Accuracy = \frac{TP + TN}{TP + FP + TN + FN} \tag{17}$$

In the above equations, TP (true positive) is the total number of epileptic patients diagnosed with epilepsy, TN (true negative) is the total number of normal patients diagnosed as healthy, FP is the total number of epileptic patients diagnosed as healthy, and FN is the total number of normal patients diagnosed with epilepsy.

PSONNs were run separately 30 times. The training process for all PSONNs is shown in Figure 6, displaying the changes of fitness for the *gbest* particle for each PSONN during the training process. Figure 6 also shows the results of the best run among 30 runs.

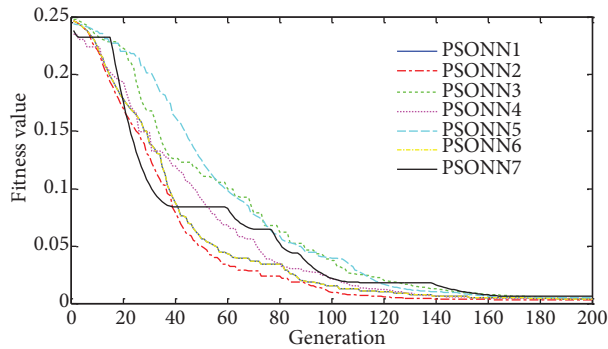

Figure 6. Training graphics of PSONNs.

Table 2. Performance of BPNN and PSONNs.

Costs/statistics	Network type							BPNN
	PSONN1	PSONN2	PSONN3	PSONN4	PSONN5	PSONN6	PSONN7	
Fitness value of best/MSE	0.0034	0.0031	0.0041	0.0038	0.0047	0.0034	0.0059	0.0009
Training accuracy (%)	87.1667	98.1667	99.6667	98.7500	84.5000	87.1667	79.0833	99.8333
Test accuracy (%)	100	100	100	100	99.2500	100	100	90.7500
Training sensitivity	1	1	1	1	1	1	0.7051	0.9967
Training specificity	0.7958	0.9646	0.9934	0.9756	0.7634	0.7958	1	1
Test sensitivity	1	1	1	1	1	1	1	0.8439
Test specificity	1	1	1	1	0.9852	1	1	1

Table 2 shows the classification accuracy rates and values of sensitivity and specificity analysis for the training and test datasets for the developed PSONN and BPNN models.

The results given in Table 2 for PSONNs are based on the best run among 30 runs. As can be seen, the best result was obtained for PSONN3. The training processes of PSONN3 and BPNN are illustrated in Figure 7.

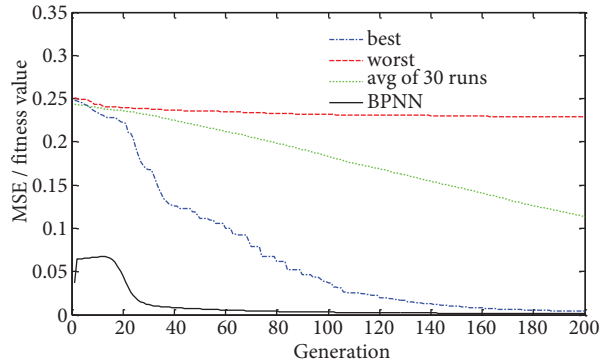

**Figure 7.** Training courses of PSONN3 and BPNN.

#### 4. Conclusions

In this work, versions of PSO and the backpropagation algorithm were used for the training of ANNs in order to diagnose epilepsy. The results the developed networks (PSONNs and BPNN) were given in Table 2. It can be seen in Table 2 that the percentages of training success for PSONN3 and PSONN4 were about 99.67% and 98.75%, respectively. The percentage of test success for both of them was 100%. The results of sensitivity analysis of these PSONN models in the training and test datasets were 1. The percentages of training and test success for the BPNN were 99.83% and 90.75%, respectively. The results of sensitivity analysis of BPNN were low in both the training and test datasets. Thus, it can be said that PSO is quite suitable for the training of ANNs, and the developed PSONN models are more successful ANN models for epilepsy diagnosis.

The classification accuracy rates of this study and other classifiers are given in Table 3 for the same dataset. As seen, the best reported result is 99.45%. In addition, PSONN3, developed in this study, has the best classification ability to diagnose epilepsy (Table 3). Furthermore, it can be said that the proposed ANN structure and its training process includes (and needs) fewer complex calculations than its counterparts in the literature.

Generally, computing load and the required amount of memory change linearly depending on the number of particles and neurons on layers. When the number of particles increases, the success of the network increases, but training of the network slows down and required memory demands increase.

The neural network models considered here for epilepsy diagnosis can be adapted for different medical diagnosis problems. An application of this study will be helpful to neurologists for epilepsy diagnosis.

**Table 3.** Comparison of classification accuracy rates (%) obtained by our approach and by other researchers for epilepsy diagnosis.

Authors	Methods	Accuracy (%)
Kannathal et al. [8]	Entropy measures, ANFIS	92.22
Güler and Übeyli [9]	SVM	99.28
Güler and Übeyli [9]	PNN	98.05
Güler and Übeyli [9]	MLPNN	93.63
Polat and Güneş [10]	FFT–decision tree	98.72
Subaşı [11]	Wavelet–ME	94.5
Subaşı [11]	Wavelet–MLPNN	93.2
Tzallas et al. [12]	TF analysis–ANN	99
Guo et al. [14]	Wavelet–ANN	95.2
Wang et al. [16]	Cross-validation–KNN	99.449
This work	PSO3	99.67
This work	PSO4	98.75

### References

- [1] I.B. Toprak, “Analysis of EEG signals using the wavelet transform and artificial neural network”, MSc, Süleyman Demirel University, Isparta, Turkey, 2007 (in Turkish with English abstract).
- [2] E. Yazgan, M. Korürek, Medikal Elektronik, İstanbul, Turkey, İTÜ, 1996 (in Turkish).
- [3] E. Sezer, “EEG signal analysis for epilepsy diagnosis”, MSc, Selçuk University, Konya, Turkey, 2008 (in Turkish with English abstract).
- [4] M.A. Çavuşlu, C. Karakuzu, F. Karakaya, “Neural identification of dynamic systems on FPGA with improved PSO learning”, *Applied Soft Computing*, Vol. 12, pp. 2707–2718, 2012.
- [5] M. Akın, M.A. Arserim, M.K. Kıymık, İ. Türkoğlu, “A new approach for diagnosing epilepsy by using wavelet transform and neural networks”, *Proceedings of the 23rd Annual EMBS International Conference*, İstanbul, Turkey, pp. 1596–1599, 2001.
- [6] A. Subaşı, A. Alkan, E. Köklükaya, “Wavelet neural network classification of EEG signals”, *Teknoloji*, Vol. 7, pp. 71–80, 2004 (in Turkish with English abstract).
- [7] N. Kannathal, M.L. Choo, U.R. Acharya, P.K. Sadasivan, “Entropies for detection of epilepsy in EEG”, *Computer Methods and Programs in Biomedicine*, Vol. 80, pp. 187–194, 2005.
- [8] İ. Güler, E.D. Übeyli, “Multiclass support vector machines for EEG-signals classification”, *IEEE Transactions on Information Technology in Biomedicine*, Vol. 11, pp. 117–126, 2007.
- [9] K. Polat, S. Güneş, “Classification of epileptiform EEG using a hybrid system based on decision tree classifier and fast Fourier transform”, *Applied Mathematics and Computation*, Vol. 187, pp. 1017–1026, 2007.
- [10] A. Subaşı, “EEG signal classification using wavelet feature extraction and a mixture of expert model”, *Expert Systems with Applications*, Vol. 32, pp. 1084–1093, 2007.
- [11] A.T. Tzallas, M.G. Tsipouras, D.I. Fotiadis, “A time-frequency based method for the detection of epileptic seizures in EEG recordings”, *Computer-Based Medical Systems Symposium*, pp. 135–140, 2007.
- [12] C.R. Hema, M.P. Paulraj, R. Nagarajan, S. Yaacob, A.H. Adom, “Application of particle swarm optimization for EEG signal classification”, *Biomedical Soft Computing and Human Sciences*, Vol. 13, pp. 79–84, 2008.
- [13] L. Guo, D. Rivero, J.A. Seoane, A. Pazos, “Classification of EEG signals using relative wavelet energy and artificial neural networks”, *Proceedings of the First ACM/SIGEVO Summit on Genetic and Evolutionary Computation*, pp. 177–183, 2009.

- [14] G. Tezel, Y. Özbay, “A new approach for epileptic seizure detection using adaptive neural network”, *Expert Systems with Applications*, Vol. 36, pp. 172–180, 2009.
- [15] D. Wang, D. Miao, C. Xie, “Best basis-based wavelet packet entropy feature extraction and hierarchical EEG classification for epileptic detection”, *Expert Systems with Applications*, Vol. 38, pp. 14314–14320, 2011.
- [16] R.G. Andrzejak, K. Lehnertz, F. Mormann, C. Rieke, P. David, C.E. Elger, “Indications of nonlinear deterministic and finite dimensional structures in time series of brain electrical activity: dependence on recording region and brain state”, *Physical Review E*, Vol. 64, p. 061907, 2001.
- [17] D. Rumelhart, J. McClelland, *Parallel Distributed Processing*, Cambridge, MA, USA, MIT Press, 1986.
- [18] J. Kennedy, R.C. Eberhart, “Particle swarm optimization”, *Proceedings of the IEEE International Conference on Neural Networks*, Vol. 4, pp. 1942–1948, 1995.
- [19] S. Bağış, “System modeling by using artificial intelligence algorithms”, MSc, Erciyes University, Kayseri, Turkey, 2009 (in Turkish with English abstract).
- [20] L. Liu, W. Liu, D.A. Cartes, “Particle swarm optimization based parameter identification applied to permanent magnet synchronous motors”, *Engineering Applications of Artificial Intelligence*, Vol. 21, pp. 1092–1100, 2008.
- [21] N. Barışçı, S. Müldür, “Classification of epileptic EEG signals using neuro-fuzzy system”, *Journal of Polytechnic*, Vol. 6, pp. 445–449, 2003 (in Turkish with English abstract).
- [22] N. Yalçın, G. Tezel, C. Karakuzu, “Epilepsy diagnosis using artificial neural network learned by PSO”, 9th International Conference on Electronics, Computer and Computation (ICECCO ‘12), pp. 37–41, 2012.
- [23] N. Yalçın, “Heuristic algorithm basis artificial neural networks for epilepsy detection”, MSc, Selçuk University, Konya, Turkey, 2012 (in Turkish with English abstract).
- [24] Y. Shi, R.C. Eberhart, “Empirical study of particle swarm optimization”, *Proceedings of the IEEE Congress on Evolutionary Computation*, pp. 1945–1950, 1999.
- [25] R.C. Eberhart, Y. Shi, “Comparing inertia weights and constriction factors in particle swarm optimization”, *Proceedings of the Congress on Evolutionary Computation*, pp. 84–88, 2000.
- [26] H.J. Park, D.U. Jeong, K.S. Park, “Automated detection and elimination of periodic ECG artifacts in EEG using the energy interval histogram method”, *IEEE Transactions on Biomedical Engineering*, Vol. 49, pp. 1526–1533, 2002.
- [27] M. Şevkli, M.M. Yenisey, “A particle swarm optimization for the job shop scheduling problems”, *İtü Dergisi/Mühendislik*, Vol. 5, pp. 58–68, 2006 (in Turkish with English abstract).
- [28] Z. Wang, X. Sun, D. Zhang, “A PSO-based classification rule mining algorithm”, *Lecture Notes in Computer Science*, Vol. 4682, pp. 377–384, 2007.
- [29] A. Özbeyaz, “LS-SVM hyper parameter selection based on PSO in EMG and EEG signals classification”, MSc, Kahramanmaraş Sütçü Imam University, Kahramanmaraş, Turkey, 2010 (in Turkish with English abstract).